

## DIAGRAMA DE MONTAGEM

R-REDONDO

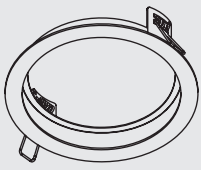

Q-QUADRADO

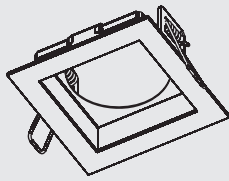

D-DUPLO

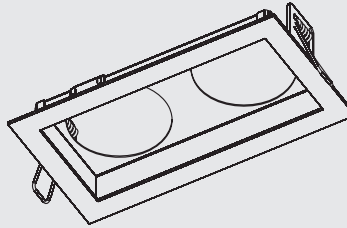

T-TRIPLO

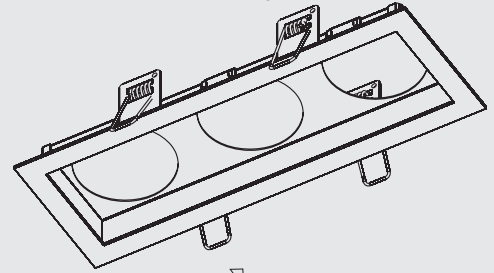

### MODULO DE LUZ

FF

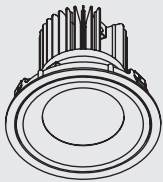

### MODULO DE LUZ

FS

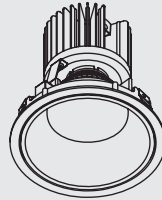

### MODULO DE LUZ

W

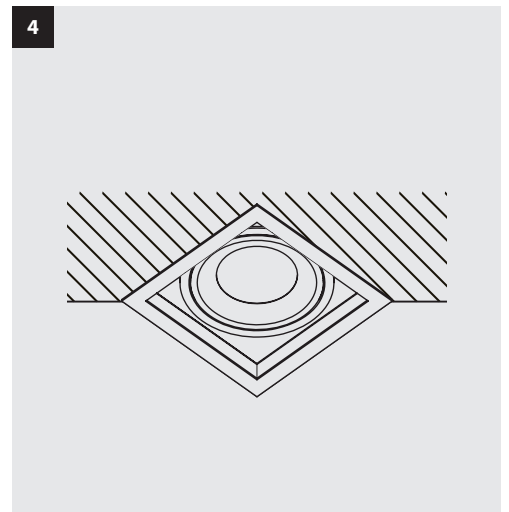
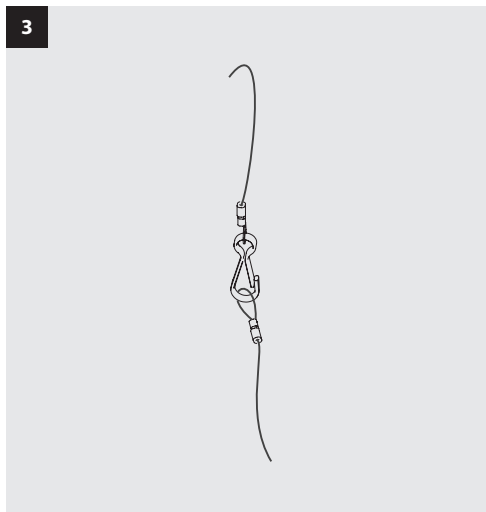
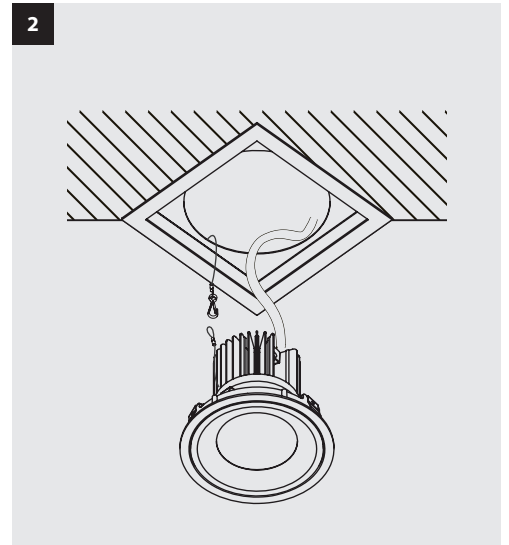
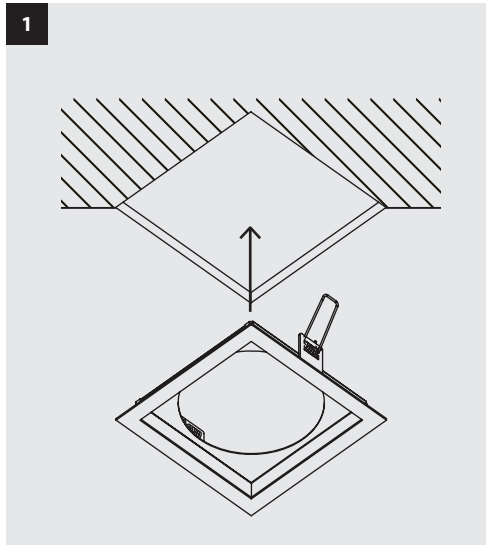
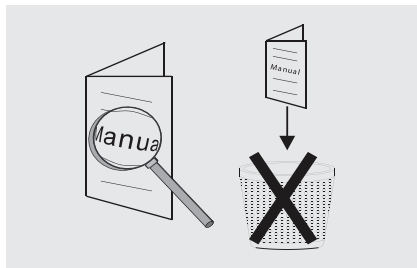
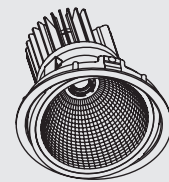

### INSTRUÇÕES DE SEGURANÇA

- O equipamento é para LED.
- Antes da instalação, certifique-se de que a fonte de alimentação está desligada.
- Siga os passos das imagens para a instalação ou substituição do equipamento.
- Depois de terminar cada passo, aperte os parafusos, fixe o aparelho e ligue a fonte de alimentação.
- Recomenda-se que estes produtos sejam instalados por um electricista qualificado.

NÃO TOQUE OU LIMPE O LED! PARA NÃO DANIFICAR A SUPERFÍCIE EMISSORA DE LUZ!

